

METRONİK TRON

PR 502 MONTAJ VE KULLANIM ŞEMASI



MENÜDEN GİRİŞ SEÇİMİ

- TUŞLARINA BİRLİKTE 5 SANİYE BASILI TUT

 YAZISI GELECEK



 TUŞUNA BASARAK İLERLE

 YAZISI GELECEK

 TUŞUNA BASILI TUTARAK  TUŞU İLE İLERLEYİP ELEMAN CİNSİNİZE UYGUN GİRİŞİ SEÇİN

 TUŞU İLE İLERLEYİN



 YAZISI GELECEK

 TUŞUNA BASILI TUTARAK  TUŞUYLA İLERLEYİP NOKTALI GÖRMEK İSTEDİĞİNİZ DURUMU SEÇİN (00.00 GİBİ)

 TUŞU İLE İLERLEYİN

AKIM VE VOLTAJ GİRİŞİ SEÇİMLERİNDE

 YAZISI GELECEK

 TUŞUNA BASILI TUTARAK  TUŞUYLA İLERLEYİP EN DÜŞÜK GİRİŞTE GÖRMEK İSTEDİĞİNİZ SKALAYI SEÇİN

 TUŞU İLE İLERLEYİN

 YAZISI GELECEK

 TUŞUNA BASILI TUTARAK  TUŞUYLA İLERLEYİP EN DÜŞÜK GİRİŞ DEĞERİNİ SEÇİN

 TUŞU İLE İLERLEYİN

 YAZISI GELECEK

 TUŞUNA BASILI TUTARAK  TUŞUYLA İLERLEYİP EN YÜKSEK GİRİŞTE GÖRMEK İSTEDİĞİNİZ SKALAYI SEÇİN



 TUŞU İLE İLERLEYİN

 YAZISI GELECEK

 TUŞUNA BASILI TUTARAK  TUŞUYLA İLERLEYİP EN YÜKSEK GİRİŞ DEĞERİNİ SEÇİN

 TUŞU İLE İLERLEYİN

 YAZISI GELECEK

 TUŞUNA BASILI TUTARAK  TUŞUYLA İLERLEYİP YES YAPARSANIZ MİNİMUMDA VE MAKSİMUMDA GÖRMEK İSTEDİĞİNİZ SKALA DEĞERLERİ TERSİNE DÖNER.

- TUŞLARINA BİRLİKTE 5 SANİYE BASILI TUTARAK İŞLEMİ TAMAMLAYIN

PR 502 İÇİN BAĞLANTI ŞEMASI

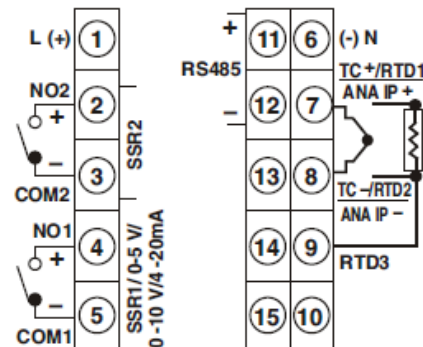

METRONİK TRON

PR 502 MONTAJ VE KULLANIM ŞEMASI

PID KONTROLÜN AKTİF EDİLMESİ

  TUŞLARINA BİRLİKTE 5 SANİYE BASILI TUT



 YAZISI GELECEK

 TUŞUNA BASILI TUTARAK  TUŞUYLA İLERLE

 YAZISI GELECEK

 TUŞU İLE İLERLEYİN



 YAZISI GELECEK

 TUŞUNA BASILI TUTARAK  TUŞUYLA İLERLEYİP YES YAPARSANIZ AUTOTUNE ÖZELLİĞİ AKTİF DURUMA GEÇER.

NOT: AUTO TUNE AKTİF DURUMA GEÇER VE CİHAZ ÜZERİNDEKİ T LEDİ YANIP SÖNMEYE BAŞLAR SÖNENE KADAR BEKLEMELİ GEREKİR. CİHAZ KENDİ PID PARAMETRESİNİ OLUŞTURUR.

 TUŞU İLE İLERLEYİN

 YAZISI GELECEK

 TUŞUNA BASILI TUTARAK  TUŞUYLA RE VE FD DURUMUNDAN İSTEDİĞİNİZ FONKSİYONU SEÇİN

RE : RÖLENİN AKTİF DURUMU

FD : RÖLENİN PASİF DURUMU

TUŞU İLE İLERLEYİN

 YAZISI GELECEK (EN DÜŞÜK ÇIKIŞ DEĞERİ 4...20mA ÇIKIŞ İÇİN GEÇERLİDİR)

 TUŞUNA BASILI TUTARAK  TUŞUYLA İLERLEYEREK EN DÜŞÜK

MİLİ AMPER ÇIKIŞ DEĞERİNİ SEÇİN

 TUŞU İLE İLERLEYİN

 YAZISI GELECEK (EN YÜKSEK ÇIKIŞ DEĞERİ 4...20mA ÇIKIŞ İÇİN GEÇERLİDİR)

 TUŞUNA BASILI TUTARAK  TUŞUYLA İLERLEYEREK EN DÜŞÜK

MİLİ AMPER ÇIKIŞ DEĞERİNİ SEÇİN

 TUŞU İLE İLERLEYİN

 YAZISI GELECEK

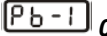
NOT:  0 OLDUĞU DURUMDA AKTİF OLUR (RÖLENİN ON-OFF ÇALIŞTIĞI DURUM)



 TUŞUNA BASILI TUTARAK  TUŞUYLA İLERLEYEREK HYSTERİSİZ BAND GENİŞLİĞİNİZİ AYARLAYIN

TUŞU İLE İLERLEYİN

 YAZISI GELECEK

 TUŞUNA BASILI TUTARAK  TUŞUYLA İLERLEYEREK PID PARAMETRESİNİ AYARLAYIN

NOT: AUTO TUNE AKTİF DURUMA GEÇERSE CİHAZ KENDİ PID PARAMETRESİNİ OLUŞTURUR.

  TUŞLARINA BİRLİKTE 5 SANİYE BASILI TUTARAK İŞLEMİ TAMAMLAYIN

NOT : SET 2 İÇİN  YAPILAN AYARLARIN AYNISINI UYGULAYIN

METRONİK TRON

PR 502 MONTAJ VE KULLANIM ŞEMASI

PROFİL KONTROLÜN AKTİF EDİLMESİ

  TUŞLARINA BİRLİKTE 5 SANİYE BASILI TUT

 YAZISI GELECEK

 TUŞUNA BASILI TUTARAK  TUŞUYLA

 DURUMUNA İLERLE



 TUŞU İLE İLERLEYİN

 YAZISI GELECEK

 TUŞUNA BASILI TUTARAK  TUŞUYLA ON DURUMUNA GETİRİN

 TUŞU İLE İLERLEYİN

 YAZISI GELECEK

 TUŞUNA BASILI TUTARAK  TUŞUYLA MAKSİMUM KULLANACAĞINIZ ADIM SAYISINI SEÇİN

 TUŞU İLE İLERLEYİN

 YAZISI GELECEK

 TUŞUNA BASILI TUTARAK  TUŞUYLA KULLANACAĞINIZ PROFİLİ SEÇİN



 TUŞU İLE İLERLEYİN

 YAZISI GELECEK



 TUŞUNA BASILI TUTARAK  TUŞUYLA KULLANACAĞINIZ PROFİLDEKİ ADIM SAYISINI SEÇİN

 TUŞU İLE İLERLEYİN

 YAZISI GELECEK



 TUŞUNA BASILI TUTARAK  TUŞUYLA ELEKTRİKLER KESİLDİĞİNDE CİHAZIN TAKİP ETMESİ GEREKEN DURUMU SEÇİN

 TUŞU İLE  DURUMUNA KADAR İLERLEYİN

 TUŞUNA BASILI TUTARAK  TUŞUYLA KULLANACAĞINIZ KADAR ADIM SEÇİN



 TUŞU İLE İLERLEYİN

 YAZISI GELECEK

 TUŞUNA BASILI TUTARAK  TUŞUYLA RÖLENİZİN AKTİF OLACAĞI DURUMU SEÇİN

 TUŞU İLE İLERLEYİN

 YAZISI GELECEK



 TUŞUNA BASILI TUTARAK  TUŞUYLA 1. ADIMDA ÇIKACAĞIN SICAKLIK DURUMUNU SEÇ

 TUŞU İLE İLERLEYİN



 YAZISI GELECEK

 TUŞUNA BASILI TUTARAK  TUŞUYLA 1. ADIM ZAMANINI SEÇ

NOT: PROGRAM SAYINIZA VE ADIM SAYINIZA GÖRE YUKARDAKİ İŞLEMİ TEKRARLAYIN

  TUŞLARINA BİRLİKTE 5 SANİYE BASILI TUTARAK İŞLEMİ TAMAMLAYIN

PROGRAM SEÇİMİ VE BAŞLATMA

 TUŞUNA BASILI TUTARAK  TUŞUYLA  DURUMUNA KADAR İLERLEYİN

 TUŞUNA BASILI TUTARAK  TUŞUYLA KULLANACAĞINIZ PROGRAM NUMARASINI SEÇİN

 TUŞUNA BASILI TUTARAK  TUŞUYLA  DURUMUNA GEL

METRONİK TRON

PR 502 MONTAJ VE KULLANIM ŐEMASI

 TUŐUNA BASILI TUTARAK  TUŐUYLA

RUN DURUMUNU SEŐERSEN PROGRAM BAŐLAR

STOP DURUMUNU SEŐERSEN PROGRAM STOP
EDER

 TUŐUNA BASILI TUTARAK  TUŐUYLA

 DURUMUNA GEL

 DURUMUNDA PROGRAMIN ŐALIŐTIĐI
SÜREYİ GÖRÜRSÜNÜZ